

SKW92B IoT WLAN Module Datasheet

Document Information	
Title	802.11b/g/n IoT WLAN Module
Document type	Datasheet
Document number	SL-18060058
Revision and date	V1.07 12-Mar-2020
Disclosure restriction	Public

This document applicable to the following products :

Product name	Type number	Product status
802.11b/g/n IoT WLAN Module	SKW92B (0920101)	Mass Production
	SKW92B (0920102)	
	SKW92B (0920105)	
	SKW92B (0920106)	
	SKW92B (0920107)	
	SKW92B (0920108)	
	SKW92B (0920109)	

SKYLAB reserves all rights to this document and the information contained herein. Products, names, logos and designs described herein may in whole or in part be subject to intellectual property rights. Reproduction, use, modification or disclosure to third parties of this document or any part thereof without the express permission of SKYLAB is strictly prohibited.

The information contained herein is provided "as is" and SKYLAB assumes no liability for the use of the information. No warranty, either express or implied, is given, including but not limited, with respect to the accuracy, correctness, reliability and fitness for a particular purpose of the information. This document may be revised by SKYLAB at any time. For most recent documents, visit www.skylab.com.cn.

Copyright © 2018, Skylab M&C Technology Co., Ltd.

SKYLAB® is a registered trademark of Skylab M&C Technology Co., Ltd in China

Contents

1 General Description.....	4
2 Applications.....	4
3 Features.....	5
4 Application Block Diagram.....	6
5 Interfaces.....	6
USB.....	6
I2C.....	6
SD-XC/eMMC.....	6
I2S(192K/24bits).....	7
PCM.....	9
PWM.....	9
SPI slave.....	10
UARTS lite.....	10
GPIO.....	10
WAN/LAN.....	12
6 Module Specifications.....	12
7 Module Pinout and Pin Description.....	13
Module Pinout:.....	13
Pin Description:.....	13
8 Mechanical specifications.....	15
10 Electrical Characteristics.....	16
11 Manufacturing Process Recommendations.....	18
12 Packaging Specification.....	19
13 Ordering Information.....	19
14 Revision History.....	19
15 Contact Information.....	20

1 General Description

The SKW92B module integrates a 1T1R 802.11n Wi-Fi radio, a 580MHz MIPS CPU, 1-port fast Ethernet PHY, USB2.0 host, I2C/PCM and multiple slow IOs.

The module provides two operation modes – IoT gateway mode and IoT device mode. In IoT gateway mode, the high performance USB2.0 allows SKW92B to add 3G/LTE modem support or add a H.264 ISP for wireless IP camera. For the IoT device mode, the module supports eMMC, SD-XC and USB2.0. In IoT device mode, it further supports PWM, SPI slave, 3rd UART and more GPIOs. For IoT gateway, it can connect to touch panel and BLE, Zigbee/Z-wave and sub-1G RF for smart home control.



Figure 1: SKW92B Top View

2 Applications

- ◆ IoT (internet of things)
- ◆ 3G/4G WiFi Router
- ◆ USB WiFi Camera
- ◆ Building Automation
- ◆ Home Automation
- ◆ Smart Home Gateway
- ◆ Smart Lighting
- ◆ Smart Plug
- ◆ Industry Control

3 Features

- ◆ Compliant to IEEE 802.11b/g/n.
- ◆ 1T1R 2.4GHz with support for a 150Mbps PHY data rate.
- ◆ DDR2 memory up to 1024Mb.
- ◆ Flash memory up to 512Mb.
- ◆ 4 LAN ports and 1 WAN port.
- ◆ Support USB 2.0 slave device for USB disk and USB 3G/4G dongle and USB camera.
- ◆ 24 STA-Proxy.
- ◆ Support interface: SD-XC, I2C, PCM, I2S(192K/24bits), PWM, SPI slave, UART lite, GPIO.
- ◆ Security: WEP64/128, TKIP, AES, WPA, WPA2, WAPI.
- ◆ Support IoT gateway mode and IoT device mode .
- ◆ RoHS compliance meets environment-friendly requirement.
- ◆ Conform to FCC/CE/IC/RoHS certification standards.
- ◆ 40.5mm(L) x 25mm(W) x 3.0mm(H) dimension.

4 Application Block Diagram

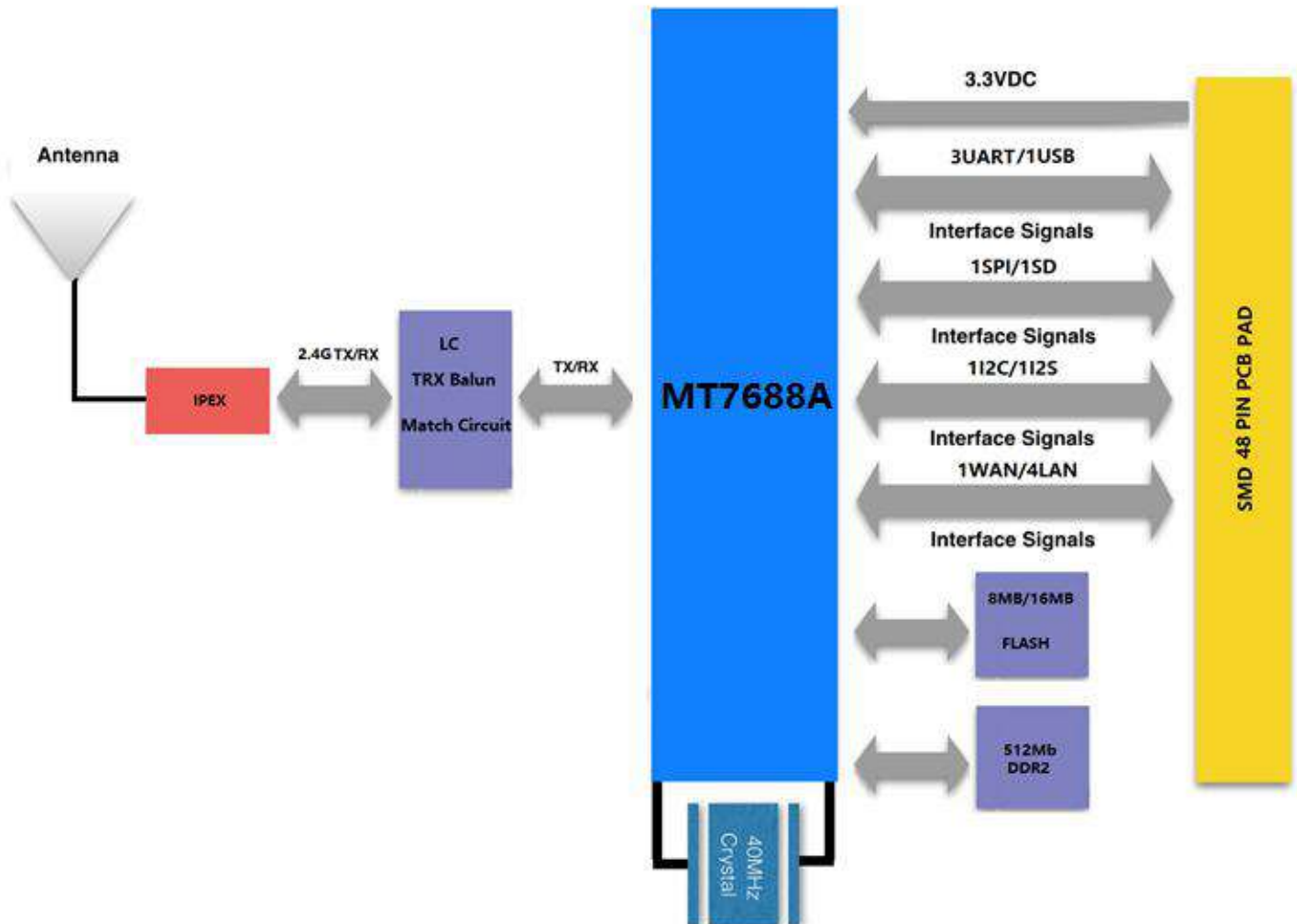

Figure 2: SKW92B Block Diagram

5 Interfaces

USB

The USB interface support USB slave devices for USB disk and USB 3G/4G dongle and USB camera.

I2C

SKW92B Pin Number	Pin Name	GPIO(2'b01)	I2C(2'b00)
46	I2C_SD	GPIO#05	I2C_SD
47	I2C_CLK	GPIO#04	I2C_CLK

Table5-1: I2C pin share scheme

Note: Controlled by I2C_MODE register

SD-XC/eMMC

SKW92B Pin Number	Pin Name(4'b0000)	GPIO(2'b01)	SD(2'b00)	eMMC(2'b00)
-------------------	-------------------	-------------	-----------	-------------

24	LAN_PORT4_TX-	GPIO#29	SD_D2	eMMC_D3
23	LAN_PORT4_TX+	GPIO#28	SD_D3	eMMC_CMD
22	LAN_PORT4_RX-	GPIO#27	SD_CMD	eMMC_D2
21	LAN_PORT4_RX+	GPIO#26	SD_CLK	eMMC_CLK
16	LAN_PORT3_RX-	GPIO#25	SD_D0	eMMC_D0
15	LAN_PORT3_RX+	GPIO#24	SD_D1	eMMC_D1
14	LAN_PORT3_TX-	GPIO#23	SD_CD	eMMC_CD
13	LAN_PORT3_TX+	GPIO#22	SD_WP	eMMC_WP

Table5-2: SD-XC/eMMC pin share scheme

Note: Controlled by the EPHY_APGIO_AIO_EN[4:1] and SD_MODE register

I2S(192K/24bits)

SKW92B Pin Number	Pin Name	GPIO(2'b01)	I2S(2'b00)	PCM(2'b10)
44	I2S_CLK	GPIO#03	I2S_CLK	PCMFS
42	I2S_WS	GPIO#02	I2S_WS	PCMCLK
43	I2S_SDO	GPIO#01	I2S_SDO	PCMDTX
41	I2S_SDI	GPIO#0	I2S_SDI	PCMDRX

Table5-3: I2S/PCM pin share scheme

Note: Controlled by I2S_MODE register

Transmitter

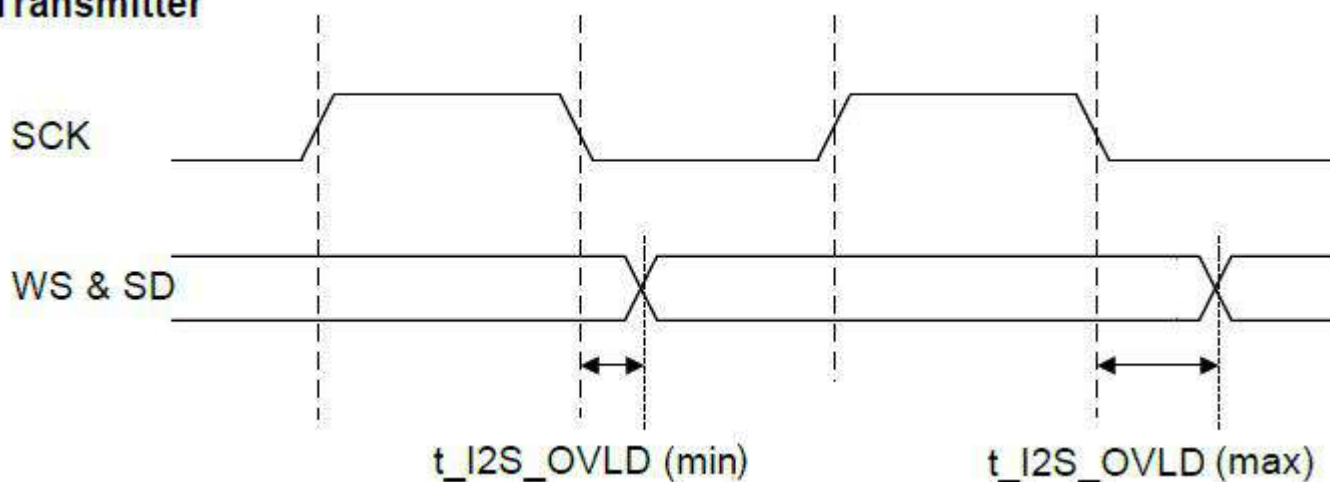

Receiver

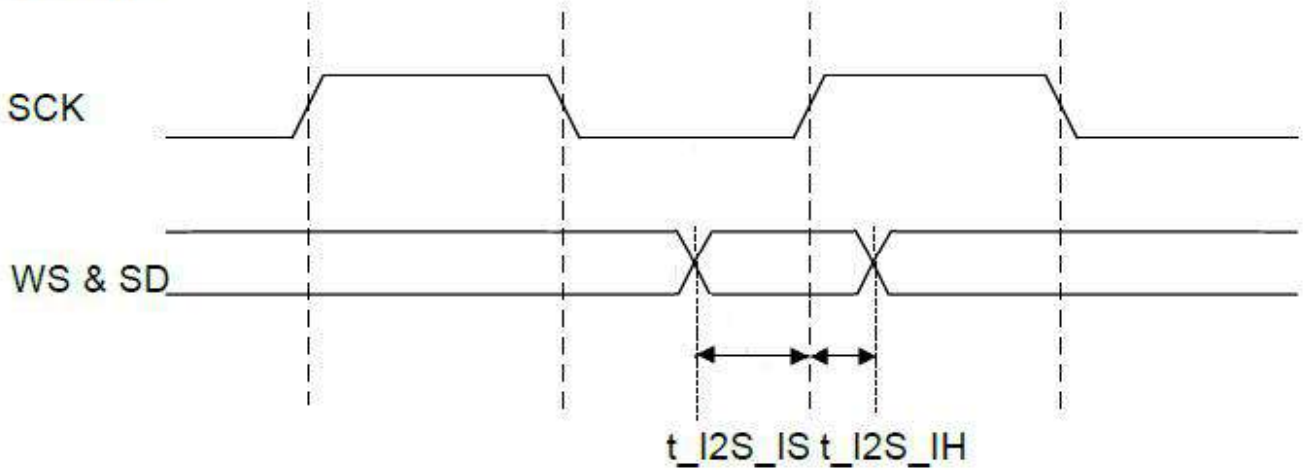

Figure 3: I2S Timing

Symbol	Description	Min	Max	Unit
t_{I2S_IS}	Setup Time for I2S input(data & WS)	3.5		ns
t_{I2S_IH}	Hold Time for I2S input(data & WS)	0.5		ns
t_{I2S_OVLD}	I2S_CLK to I2S output(data & WS) valid	2.5	10	ns

Table5-4: I2S Interface Diagram Key

PCM

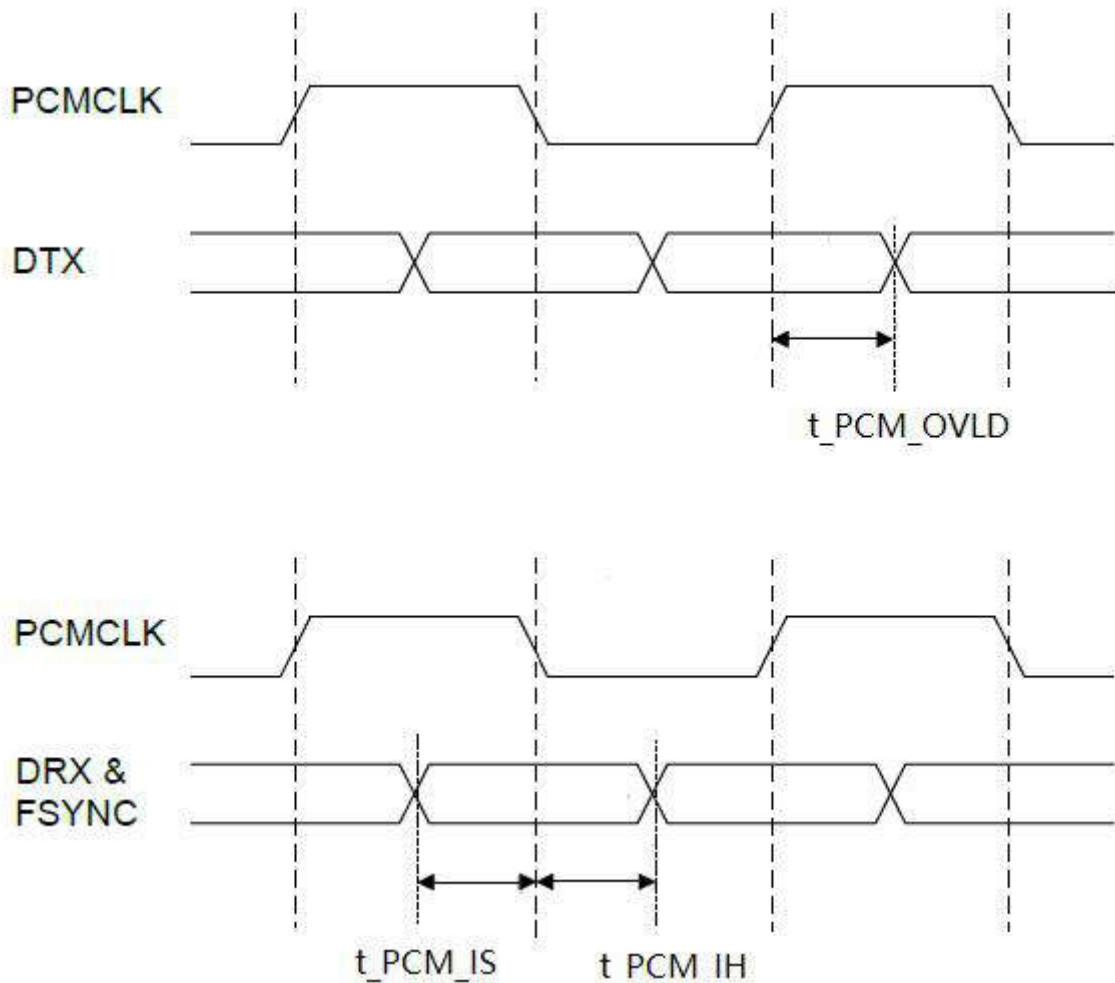

Figure 4: PCM Timing

Symbol	Description	Min	Max	Unit
t_PCM_IS	Setup Time for PCM input to PCM_CLK fall	3.5		ns
t_PCM_IH	Hold Time for PCM input to PCM_CLK fall	1.0		ns
t_PCM_OVLD	PCM_CLK to PCM output valid	10.0	35.0	ns

Table5-5: PCM Interface Diagram Key

PWM

SKW92B Pin Number	Pin Name	GPIO	PWM	Pin Share
10	LAN_PORT2_RX-	GPIO#19	PWM1	SD_D6
9	LAN_PORT2_RX+	GPIO#18	PWM0	SD_D7

Table5-6: PWM pin share scheme

SPI slave

SKW92B Pin Number	Pin Name(4'b0000)	GPIO(2'b01)	SPIS(2'b00)	2'b11
8	LAN_PORT1_RX-	GPIO#17	SPIS_MOSI	UART_RXD2
7	LAN_PORT1_RX+	GPIO#16	SPIS_MISO	UART_TXD2
6	LAN_PORT1_TX-	GPIO#15	SPIS_CLK	PWM_CH1
5	LAN_PORT1_TX+	GPIO#14	SPIS_CS	PWM_CH0

Table5-7: SPIS pin share scheme

Note: Controlled by the EPHY_APGIO_AIO_EN[4:1] and SPIS_MODE register

UARTS lite

The module support 3UART:

SKW92B Pin Number	Pin Name	GPIO	UART	Pin Share
25	UART_RXD0	GPIO#13	UART0_RXD	UART0(For Debug)
26	UART_TXD0	GPIO#12	UART0_TXD	
38	UART_RXD1	GPIO#46	UART1_RXD	PWM_CH1
37	UART_TXD1	GPIO#45	UART1_TXD	PWM_CH0
12	LAN_PORT2_TX-	GPIO#21	UART2_RXD	PWM_CH3/SD_D4
11	LAN_PORT2_TX+	GPIO#20	UART2_TXD	PWM_CH2/SD_D5

Table5-8: UART pin share scheme

GPIO

SKW92B Pin Number	GPIO	Description	Share function
38	GPIO#46	Uart1_RXD	UART1
37	GPIO#45	Uart1_TXD	
36	GPIO#44	WLED_N	Wireless LED
35	GPIO#43	P0_LED	Port LED
34	GPIO#42	P1_LED	
33	GPIO#41	P2_LED	
32	GPIO#40	P3_LED	
31	GPIO#39	P4_LED	

39	GPIO#38	WDT_RST_N	WPS/Factory Setting	
40	GPIO#37	WPS_LED	WPS LED	
24	GPIO#29	MDI_TN_P4	SD-XC/eMMC	
23	GPIO#28	MDI_TP_P4		
22	GPIO#27	MDI_RN_P4		
21	GPIO#26	MDI_RP_P4		
16	GPIO#25	MDI_RN_P3		
15	GPIO#24	MDI_RP_P3		
14	GPIO#23	MDI_TN_P3		
13	GPIO#22	MDI_TP_P3		
12	GPIO#21	MDI_TN_P2		UART2
11	GPIO#20	MDI_TP_P2		
10	GPIO#19	MDI_RN_P2	PWM1	
9	GPIO#18	MDI_RP_P2	PWM0	
8	GPIO#17	MDI_RN_P1	SPIS	
7	GPIO#16	MDI_RP_P1		
6	GPIO#15	MDI_TN_P1		
5	GPIO#14	MDI_TP_P1		
25	GPIO#13	UART0_RXD	Uart0(For Debug)	
26	GPIO#12	UART0_TXD		
48	GPIO#11	GPIO0	GPIO0	
46	GPIO#05	I2C_SD	I2C	
47	GPIO#04	I2C_CLK		
44	GPIO#03	I2S_CLK/PCMFS	I2S/PCM	
42	GPIO#02	I2S_WS/PCMCLK		
43	GPIO#01	I2S_SDO/PCMDTX		
41	GPIO#0	I2S_SDI/PCMDRX		

Table5-9: GPIO pin share scheme

WAN/LAN

In IoT gateway mode, the module integrates 5-port 10/100Mbps fast Ethernet switches; in IoT device mode, the module integrates 1-port 10/100Mbps fast Ethernet switch.

6 Module Specifications

Hardware Features	
Model	SKW92B
Antenna Type	IPEX
Chipset solution	MT7688AN
Voltage	3.3V±5%
Dimension(L×W×H)	40.5mm*25.0mm*3.0mm
Wireless Features	
Wireless Standards	IEEE 802.11b/g/n
Frequency Range	2.412GHz---24.884GHz
Data Rates	IEEE 802.11b : 1,2,5.5,11Mbps
	IEEE 802.11g : 6,9,12,18,24,36,48,54Mbps
	IEEE 802.11n : MCS0--MCS7 @ HT20
	MCS0--MCS7 @ HT40
Receiver Sensitivity	HT40 MCS7 : -70dBm@10% PER(MCS7)
	HT20 MCS7 : -73dBm@10% PER(MCS7)
	54M: -77dBm@10% PER
	11M: -89dBm@ 8% PER
Modulation Technique	DSSS (DBPSK, DQPSK, CCK)
	OFDM (BPSK, QPSK, 16-QAM, 64-QAM)
Wireless Security	WPA/WPA2, WEP, TKIP and AES, WPS2.0, WAPI
Transmit Power	IEEE 802.11n: 16dBm @HT20/40 MCS7
	IEEE 802.11g: 16dBm @54MHz
	IEEE 802.11b: 18dBm @11MHz
Work Mode	IoT Gateway/IoT Device
Others	

Certification	RoHS
Environment	Operating Temperature: -20℃~55℃
	Storage Temperature: -40℃~125℃
	Operating Humidity: 10%~90% non-condensing
	Storage Humidity: 5%~90% non-condensing

7 Module Pinout and Pin Description

Module Pinout:

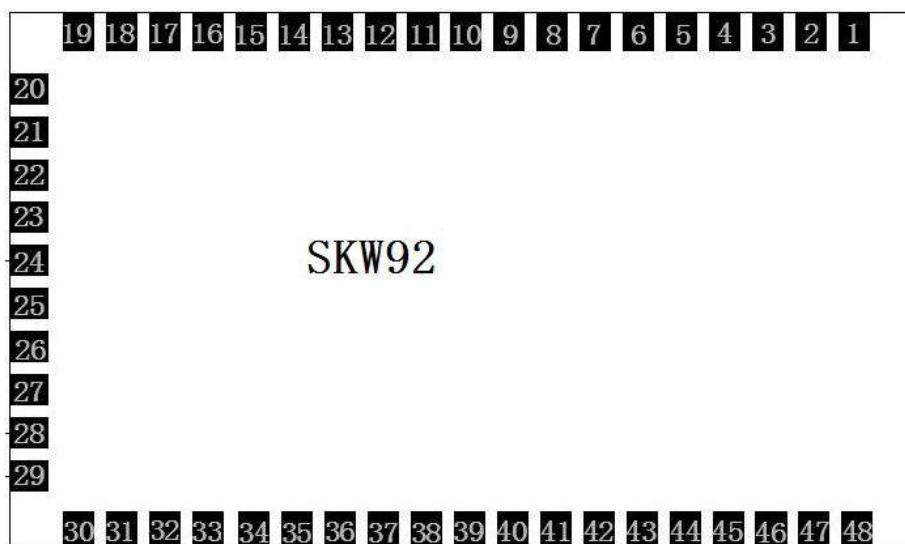

Figure 5: SKW92B Pin Package

Pin Description:

Pin No.	Pin name	Description	Remark
1	WAN_PORT_RX+	WAN port	WAN_RX+
2	WAN_PORT_RX-	WAN port	WAN_RX-
3	WAN_PORT_TX+	WAN port	WAN_TX+
4	WAN_PORT_TX-	WAN port	WAN_TX-
5	LAN_PORT1_TX+	Ethernet port1	SPIS_CS / GPIO#14 / PWM0
6	LAN_PORT1_TX-	Ethernet port1	SPIS_CLK / GPIO#15 / PWM1
7	LAN_PORT1_RX+	Ethernet port1	SPIS_MISO / GPIO#16 /

8	LAN_PORT1_RX-	Ethernet port1	SPIS_MOSI / GPIO#17 /
9	LAN_PORT2_RX+	Ethernet port2	GPIO#18 / PWM0 / SD_D7
10	LAN_PORT2_RX-	Ethernet port2	GPIO#19 / PWM1 / SD_D6
11	LAN_PORT2_TX+	Ethernet port2	GPIO#20 / PWM2 / UART2_TXD /
12	LAN_PORT2_TX-	Ethernet port2	GPIO#21 / PWM3 / UART2_RXD /
13	LAN_PORT3_TX+	Ethernet port3	SD_WP / GPIO#22
14	LAN_PORT3_TX-	Ethernet port3	SD_CD / GPIO#23
15	LAN_PORT3_RX+	Ethernet port3	SD_D1 / GPIO#24
16	LAN_PORT3_RX-	Ethernet port3	SD_D0 / GPIO#25
17	GND	Ground	GND
18	USB+	USB data pin Data+	USB_D+
19	USB-	USB data pin Data-	USB_D-
20	GND	Ground	GND
21	LAN_PORT4_RX+	Ethernet port4	SD_CLK / GPIO#26
22	LAN_PORT4_RX-	Ethernet port4	SD_CMD / GPIO#27
23	LAN_PORT4_TX+	Ethernet port4	SD_D3 / GPIO#28
24	LAN_PORT4_TX-	Ethernet port4	SD_D2 / GPIO#29
25	UART_RXD0	UART0 only for debug	UART0_RX / GPIO#13
26	UART_TXD0	UART0 only for debug	UART0_TX / GPIO#12 / O, IPD
27	GND	Ground	GND
28	3.3VD	3.3V input 1000mA	+3.3V
29	3.3VD	3.3V input 1000mA	+3.3V
30	GND	Ground	GND
31	P4_LED	LAN_PORT4_LED	P4_LED_N / GPIO#39
32	P3_LED	LAN_PORT3_LED	P3_LED_N / GPIO#40
33	P2_LED	LAN_PORT2_LED	P2_LED_N / GPIO#41
34	P1_LED	LAN_PORT1_LED	P1_LED_N / GPIO#42
35	P0_LED	WAN_PORT_LED	P0_LED_N / GPIO#43
36	WLED_N	Wireless LED	WLED_N / GPIO#44

37	UART_TXD1	UART1 Serial Data Output	UART1_TXD / GPIO#45 / O, IPU
38	UART_RXD1	UART 1 Serial Data Input	UART1_RXD / GPIO#46
39	WDT_RST_N	WPS/Factory	WDT_RST_N / I2S_MCLK /
40	WPS_LED	WPS_LED	WPS_LED_N / GPIO#37
41	I2S_DI	I2S data input	I2S_SDI/GPIO#0/PCMDRX
42	I2S_WS	I2S word select	I2S_WS/GPIO#2/PCMCLK
43	I2S_DO	I2S data output	I2S_SDO /GPIO#1/PCMDTX/IPD
44	I2S_CLK	I2S clock	I2S_CLK/GPIO#3/PCMFS
45	HW_RESET	Power on reset	HW_RESET_N#
46	I2C_SD	I2C Data	I2C_SDA(PU 2K2) / GPIO#5
47	I2C_SCLK	I2C clock	I2C_SCL(PU 2K2) / GPIO#4
48	GPIO0	General Purpose I/O	POWER_ON# / GPIO#11/IPD

8 Mechanical specifications

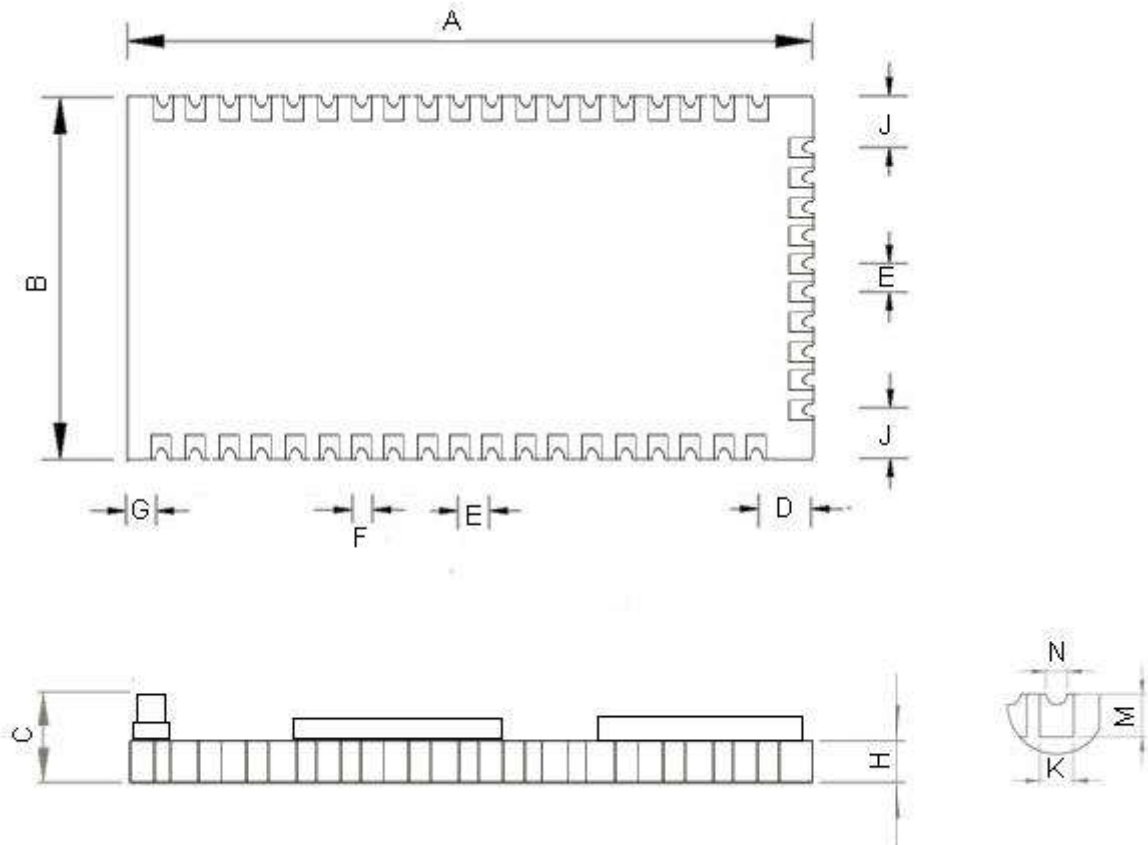

Symbol	Min.(mm)	Typ.(mm)	Max.(mm)
A	40.4	40.5	41.3
B	24.9	25	25.1
C	2.6	2.8	3
D	1.9	3	3.4
E	1.9	2	2.1
F	1.3	1.4	1.5
G	1.4	1.5	1.9
H	1.1	1.2	1.3
J	3.4	3.5	3.6
K	1.3	1.4	1.5
M	1.4	1.5	1.6
N	0.8	0.9	1

9 PCB Footprint and Dimensions

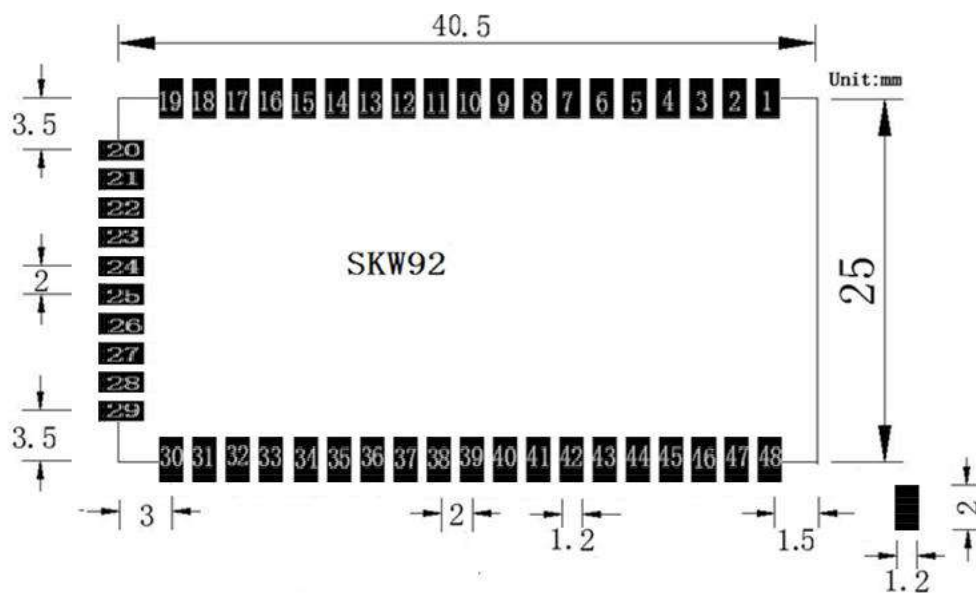

Figure 6: SKW92B Recommend PCB Footprint

10 Electrical Characteristics

a) Absolute Maximum Ratings

Parameter	Condition	Min	Typ.	Max.	Unit
-----------	-----------	-----	------	------	------

Storage temperature range		-40		125	°C
ESD Protection	VESD	/		2000	V
Supply voltage	VDD_3.3V	0		3.6	V
Voltage on any I/O pin		-0.3		3.63	V

Table9-1: Absolute Maximum Ratings

Note: Absolute maximum ratings are stress ratings only, and functional operation at the maxims is not guaranteed. Stress beyond the limits specified in this table may affect device reliability or cause permanent damage to the device. For functional operating conditions, refer to the operating conditions tables as follow.

*SKW92B series modules are Electrostatic Sensitive Devices and require special precautions while handling.



ESD precautions

The SKW92B series modules contain highly sensitive electronic circuitry and are Electrostatic Sensitive Devices (ESD). Handling the SKW92B series modules without proper ESD protection may destroy or damage them permanently.

The SKW92B series modules are electrostatic sensitive devices (ESD) and require special ESD precautions typically applied to ESD sensitive components. Proper ESD handling and packaging procedures must be applied throughout the processing, handling, transportation and operation of any application that incorporates the SKW92B series module. Don't touch the module by hand or solder with non-anti-static soldering iron to avoid damage to the mode.

b) Recommended Operation Ratings

Parameter	Symbol	Minimum	Typical	Maximum	Unit
Extended temp. range	TA	-20		55	°C
Power Supply	VDD_3.3V	3.14	3.3	3.46	V
Input Low Voltage	VIL	-0.3		0.8	V

Input High Voltage	VIH	2		3.63	V
--------------------	-----	---	--	------	---

Table9-2: Operating Conditions

c) Measurement Conditions

System state	Current (Typ.)@3.3V	Current (Max.)@3.3V
Standby	160 mA	
Transmit (2.4g; +15 dBm @ TX HT20 MCS7.)	260 mA	
Transmit (2.4g; +18 dBm @ 11b 11Mbps.)	400 mA	500 mA

Table9-3: Power Consumption in Different States

11 Manufacturing Process Recommendations

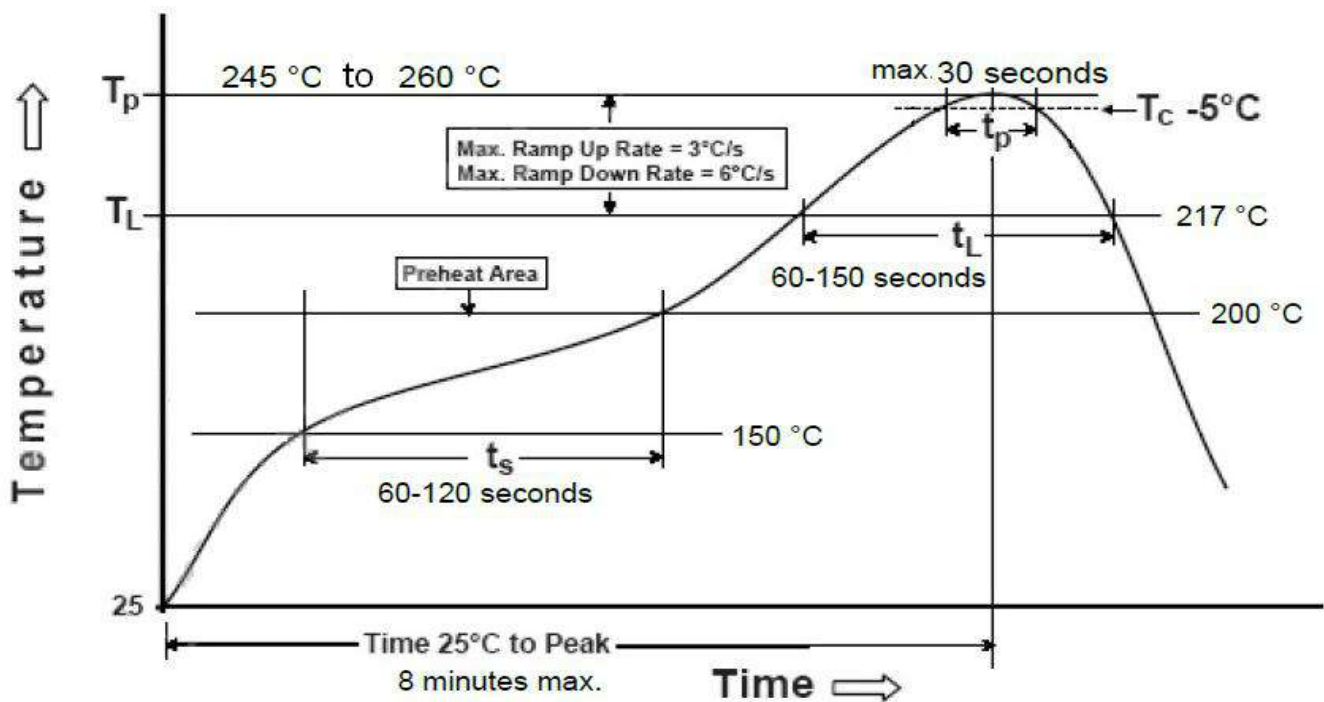
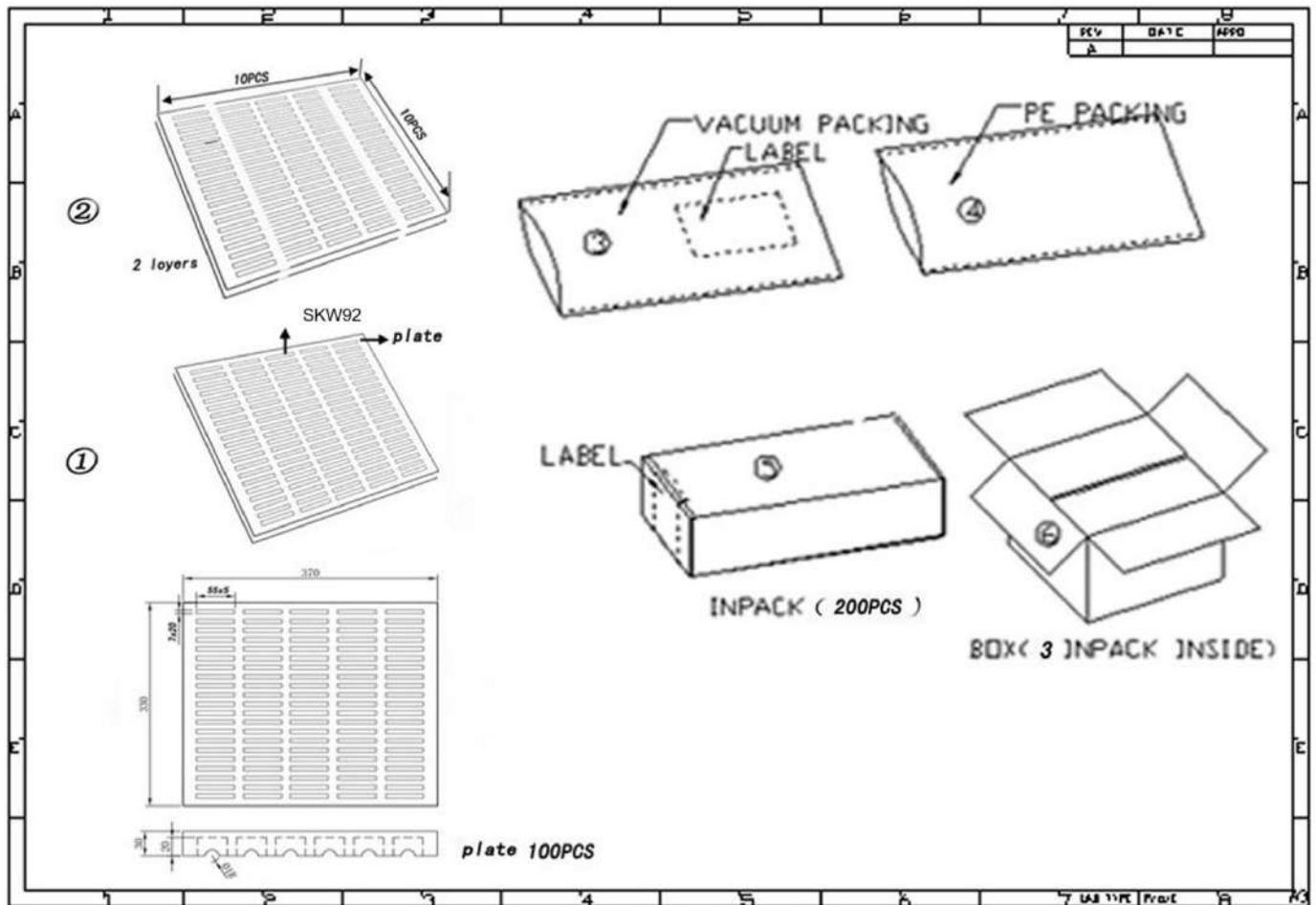

Figure 7: SKW92B Typical Lead-free Soldering Profile

Note: The final soldering temperature chosen at the factory depends on additional external factors like choice of soldering paste, size, thickness and properties of the baseboard, etc. Exceeding the maximum soldering temperature in the recommended soldering profile may permanently damage the module.

12 Packaging Specification



13 Ordering Information

Module No.	SPI Flash Size	DDR2 Size
SKW92B_E8	8M Bytes	512M bits
SKW92B_E16	16M Bytes	512M bits
SKW92B_E325	32M Bytes	512M bits
SKW92B_E321	32M Bytes	1024M bits
SKW92B_E641	64M Bytes	1024M bits

14 Revision History

Revision	Description	Approved	Date
V1.01	Initial Release	Sunny Pan	20151228

V1.02	Update Pin Description	George He	20160317
V1.03	Update Power Consumption	George He	20170413
V1.04	Update Ordering Information	George He	201701016
V1.05	Update Wireless Features Information	George He	20180605
V1.06	Add Mechanical specifications and Packaging Specification	George He	20190125
V1.07	Update Ordering Information	George He	20200312

15 Contact Information

Skylab M&C Technology Co., Ltd.

深圳市天工测控技术有限公司

Address: 6 Floor, No.9 Building, Lijincheng Scientific & Technical park, Gongye East Road,
Longhua District, Shenzhen, Guangdong, China

Phone: 86-755 8340 8210 (Sales Support)

Phone: 86-755 8340 8510 (Technical Support)

Fax: 86-755-8340 8560

E-Mail: sales1@skylab.com.cn

Website: www.skylab.com.cn www.skylabmodule.com